

The Bravo fire pit is handmade by Dekko in North America. Ships with your choice of NG or LP burner, one decorative aggregate option and chrome On/Off key.

Size: 32"W x 32"D x 13"H
 CSA/UL Approved Burner Assembly



	Manual Ignition	Electronic Ignition
BTU/Hr	65,000	65,000
Weight	115 lbs	115 lbs
Fuel Options	NG/LP	NG/LP

Optional Accessories:

- Propane Tank Cover 16"W x 16"D x 21"H
- Glass Wind Guard 23"D x 6"H
- Vinyl Weather Cover
- Powder Coated Aluminium Table Top 32"W x 32"D

Colour Options

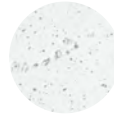

NATURAL

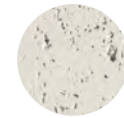

LIMESTONE

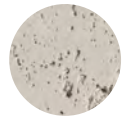

CLAY

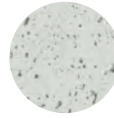

ASH

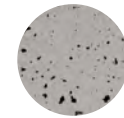

SANDSTONE

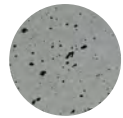

CHARCOAL

Decorative Aggregate Options



IVORY BEACH STONE



SLATE BEACH STONE



BLACK LAVA ROCK

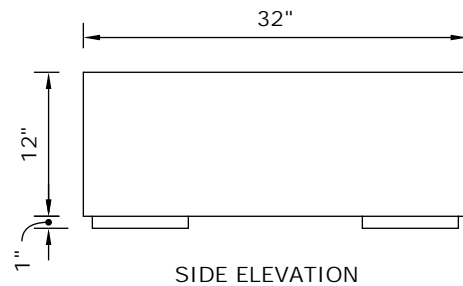
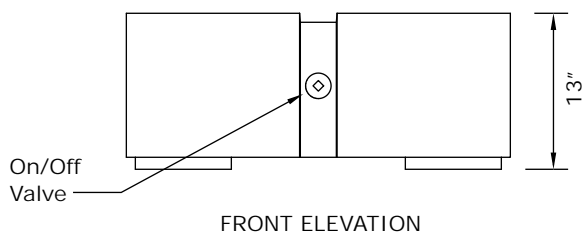
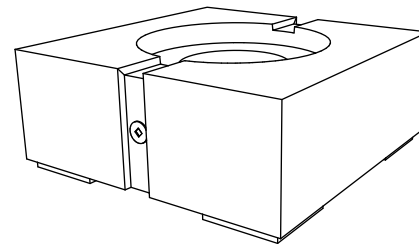
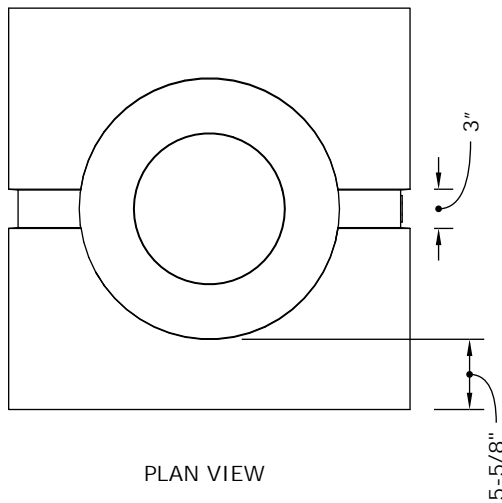

Clearances

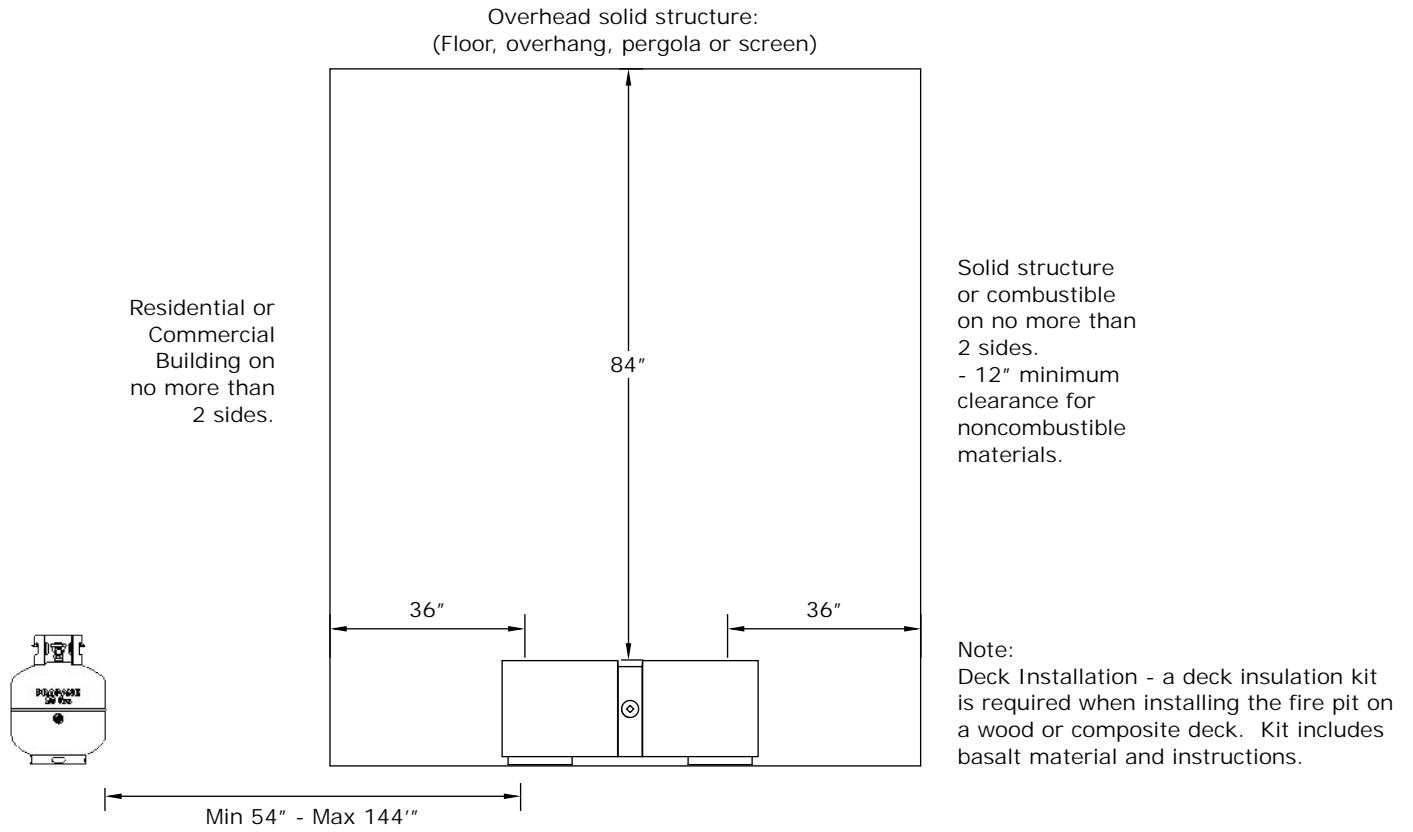

Burner Assembly

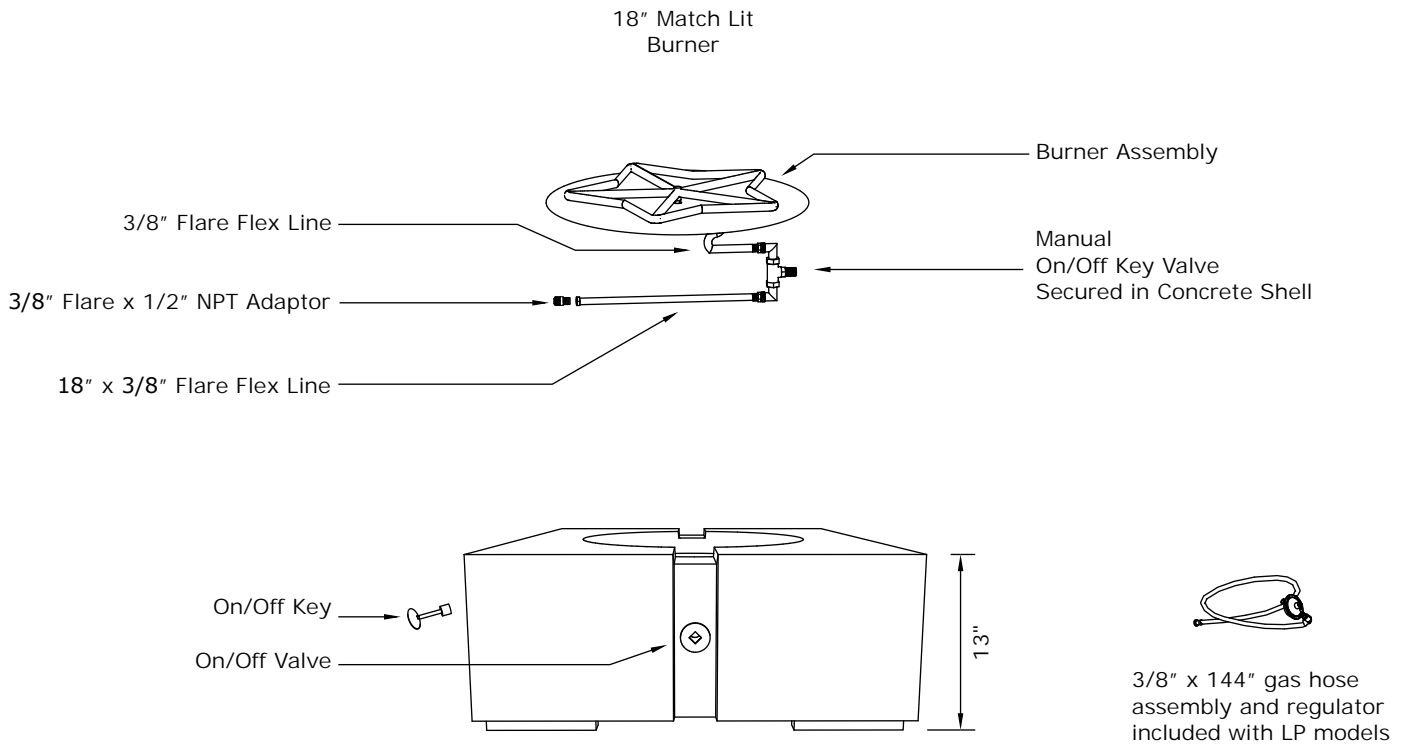



Clearances

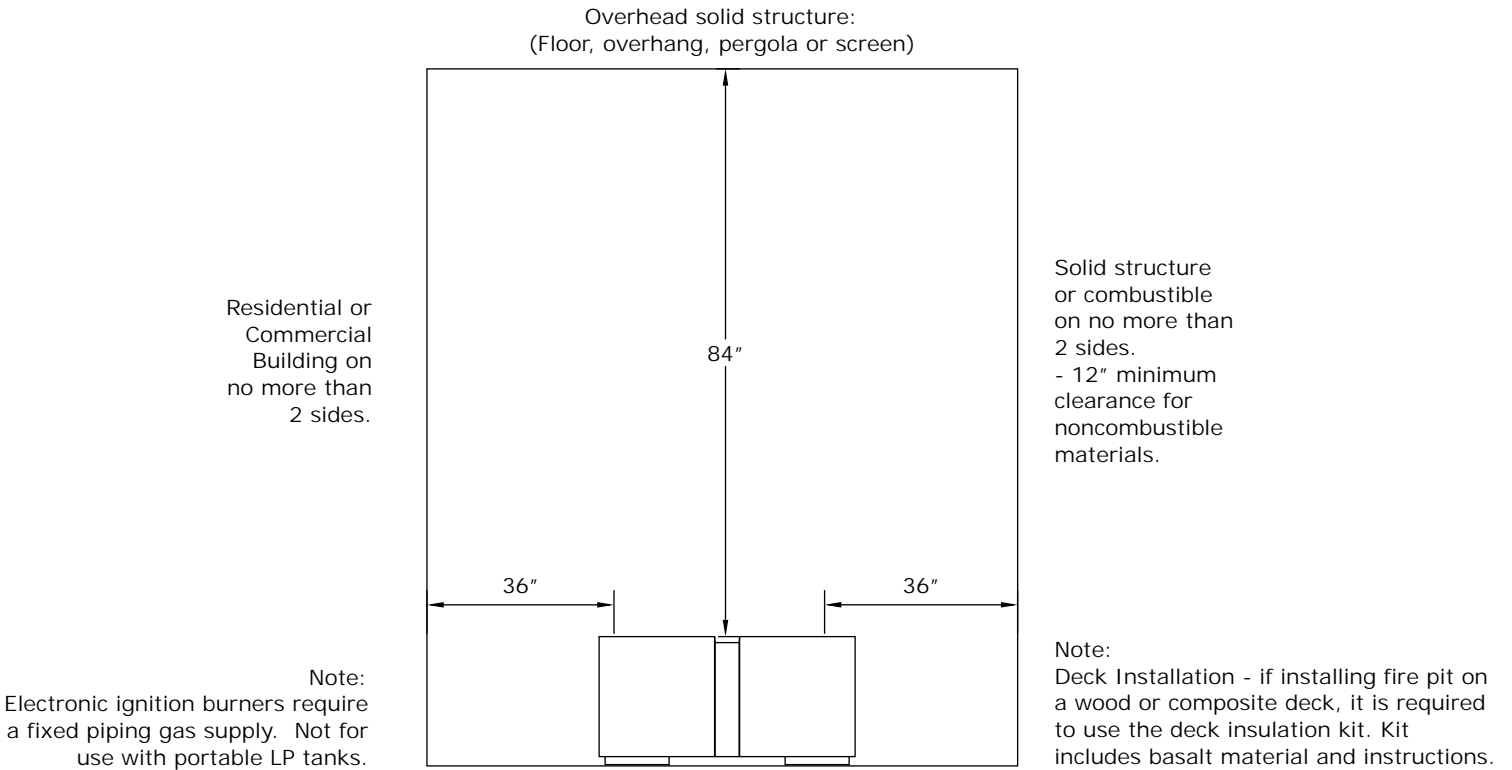

Burner Assembly

Electrical:
120V Outdoor receptacle required.
Must be installed and grounded in accordance with local codes.

18" Electronic Ignition Burner

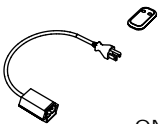
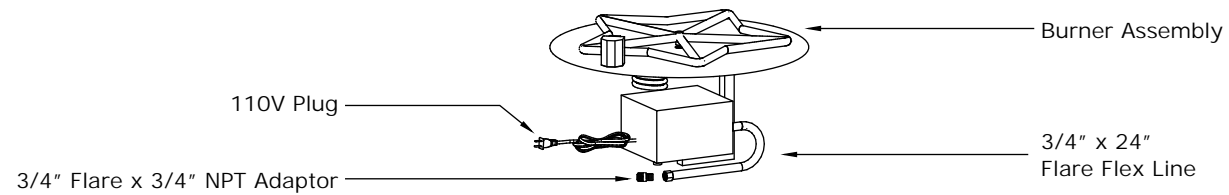

ON/OFF remote control included with Electronic Ignition models

